

Technical Data Sheet

Compressor model **B38G**
 Voltage **220-240V 50/60Hz ~1**
 Refrigerant **R134a**

APPLICATION

COMPRESSOR

MOTOR

Application	High Back Pressure	Displacement	3,80 cm ³	Nominal Power	1/8 hp
Refrigerant	R134a	Diameter	19,00 mm	Voltage/Frequency	220-240V 50Hz
Evaporating Temp.	-15,0 °C to 10,0 °C	Stroke	13,40 mm	Voltage range	187-255 V
Expansion	Capillar/Valve	Net Weight	5,40 Kg	Type	CSIR
Comp. Cooling	Static/Fan cooled	Oil type	POE 32	Phase number	1 PH
Max. ambient temp.	43,0 °C	Oil charge	120 cm ³	Locked Rotor Amps (LRA)	6,60 A
Compatible refriger.	R1234yf			Main W. resist. at 25°C	16,50 Ω
				Start W. resist. at 25°C	23,60 Ω

NOMINAL PERFORMANCE

APPROVALS

	ASHRAE	CECOMAF
Cooling Capacity	301 kCal/h	288 W
COP	2,22 W/W	1,87 W/W
EER	1,91 kCal/Wh	1,62 kCal/Wh
Input Power	157 W	154 W
Current	1,14 A	1,12 A



TEST CYCLE CONDITIONS

	ASHRAE HBP (D)	CECOMAF HBP (C)
Evaporating temp. (T _e)	7,2 °C	5,0 °C
Condensing temp. (T _c)	55,0 °C	55,0 °C
Liquid temp. (T _{liq.})	46,0 °C	55,0 °C
Ambient temp. (T _{amb.})	35,0 °C	32,0 °C
Suction temp. (T _{suction})	35,0 °C	32,0 °C
Voltage/Frequency	220 V 50 Hz	220 V 50 Hz

ELECTRICAL COMPONENTS

Starting capacitor	61 µF 330 V			
Relay	Option 1			
Reference	QL2-3.3			
Pick-Up	3,3 A			
Drop-Out	2,6 A			
Protector	Option 1			
Reference	DRB20S61A2			
Current				
Time check				
Disc temp. (Open/Close)	135,00 / 61,00 °C			

ASHRAE

Tc °C	Te °C	Cooling Capacity kCal/h	Consumption W	Current A	COP W/W	EER kCal/Wh
40	-15	142	103	1,02	1,60	1,38
40	-10	172	110	1,03	1,82	1,56
40	-5	215	117	1,04	2,13	1,83
40	0	269	124	1,06	2,52	2,16
40	5	334	131	1,07	2,97	2,55
40	7,2	367	134	1,08	3,19	2,74
40	10	412	138	1,08	3,48	2,99

45	-15	135	106	1,03	1,49	1,28
45	-10	162	114	1,04	1,66	1,42
45	-5	201	122	1,05	1,91	1,64
45	0	252	130	1,07	2,25	1,93
45	5	314	138	1,08	2,64	2,27
45	7,2	345	142	1,09	2,83	2,43
45	10	388	146	1,10	3,09	2,65

50	-15	129	108	1,03	1,38	1,19
50	-10	152	118	1,04	1,50	1,29
50	-5	187	127	1,06	1,71	1,47
50	0	235	136	1,08	2,00	1,72
50	5	293	146	1,10	2,34	2,01
50	7,2	323	150	1,11	2,51	2,16
50	10	364	155	1,13	2,74	2,35

55	-15	122	111	1,03	1,28	1,10
55	-10	142	122	1,05	1,36	1,17
55	-5	174	132	1,07	1,53	1,32
55	0	217	143	1,10	1,77	1,53
55	5	273	153	1,12	2,08	1,78
55	7,2	301	157	1,14	2,22	1,91
55	10	340	163	1,15	2,42	2,08

60	-15	116	114	1,04	1,18	1,02
60	-10	132	126	1,06	1,23	1,05
60	-5	160	137	1,08	1,36	1,17
60	0	200	149	1,11	1,57	1,35
60	5	252	160	1,14	1,83	1,57
60	7,2	279	165	1,16	1,96	1,69
60	10	316	172	1,18	2,14	1,84

65	-15	109	117	1,04	1,09	0,94
65	-10	122	129	1,07	1,10	0,94
65	-5	147	142	1,09	1,20	1,03
65	0	183	155	1,13	1,38	1,18
65	5	232	167	1,17	1,61	1,38
65	7,2	257	173	1,19	1,73	1,48
65	10	292	180	1,21	1,89	1,62

CECOMAF

Tc °C	Te °C	Cooling Capacity W	Consumption W	Current A	COP W/W	EER kCal/Wh
40	-15	153	104	1,02	1,48	1,27
40	-10	186	111	1,03	1,68	1,45
40	-5	232	118	1,04	1,96	1,70
40	0	290	125	1,06	2,32	2,00
40	5	360	132	1,07	2,73	2,36
40	7,2	395	135	1,08	2,93	2,53
40	10	443	139	1,09	3,19	2,76

45	-15	145	106	1,03	1,36	1,18
45	-10	174	115	1,04	1,52	1,31
45	-5	216	123	1,05	1,75	1,52
45	0	270	131	1,07	2,06	1,78
45	5	336	139	1,09	2,42	2,09
45	7,2	369	143	1,10	2,59	2,24
45	10	415	147	1,11	2,82	2,44

50	-15	137	109	1,03	1,26	1,09
50	-10	162	119	1,05	1,37	1,18
50	-5	200	128	1,06	1,56	1,35
50	0	250	137	1,08	1,82	1,57
50	5	312	147	1,10	2,13	1,84
50	7,2	344	151	1,12	2,28	1,97
50	10	387	156	1,13	2,49	2,15

55	-15	129	112	1,03	1,16	1,00
55	-10	150	122	1,05	1,23	1,06
55	-5	184	133	1,07	1,38	1,20
55	0	230	143	1,10	1,60	1,38
55	5	288	154	1,12	1,87	1,62
55	7,2	318	158	1,14	2,01	1,73
55	10	359	164	1,16	2,19	1,89

60	-15	122	114	1,04	1,06	0,92
60	-10	139	126	1,06	1,10	0,95
60	-5	168	138	1,08	1,22	1,05
60	0	210	150	1,11	1,40	1,21
60	5	264	161	1,15	1,64	1,42
60	7,2	292	166	1,16	1,76	1,52
60	10	331	173	1,18	1,92	1,66

65	-15	114	117	1,04	0,97	0,84
65	-10	127	130	1,07	0,97	0,84
65	-5	152	143	1,10	1,06	0,92
65	0	190	156	1,13	1,22	1,05
65	5	240	169	1,17	1,43	1,23
65	7,2	266	174	1,19	1,53	1,32
65	10	303	181	1,21	1,67	1,44

EN12900

X	Cooling Capacity (W)	Consumption (W)	Current (A)	Mass Flow (kg/h)
1	450,5529647067	77,2936320781	0,9292999547	7,4932809719132
2	19,3788983874	-0,4410560331	-0,0033155258	0,36855385702614
3	-4,1159891579	1,2708094584	0,0032240928	-0,029077247622214
4	0,2442650114	-0,0006798334	0,0000773458	0,0069357008151163
5	-0,1668394869	0,0476784394	0,0001636821	-0,0016069174176233

Equation	$x_1 + x_2Te + x_3Tc + x_4Te^2 + x_5TeTc$
----------	---

Technical Data Sheet

COMPRESSOR DIMENSIONS

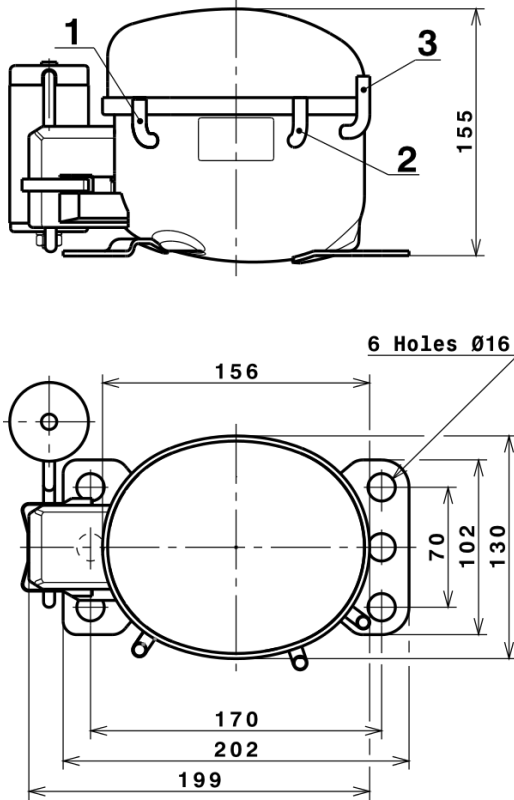

DESIGNATION	INTERNAL DIAM.
1 Suction	6,1 mm
2 Service	6,1 mm
3 Discharge	5,1 mm

WIRING DIAGRAMS AND ELECTRICAL ASSEMBLY

CSIR CONNECTION (B, Small L ranges)

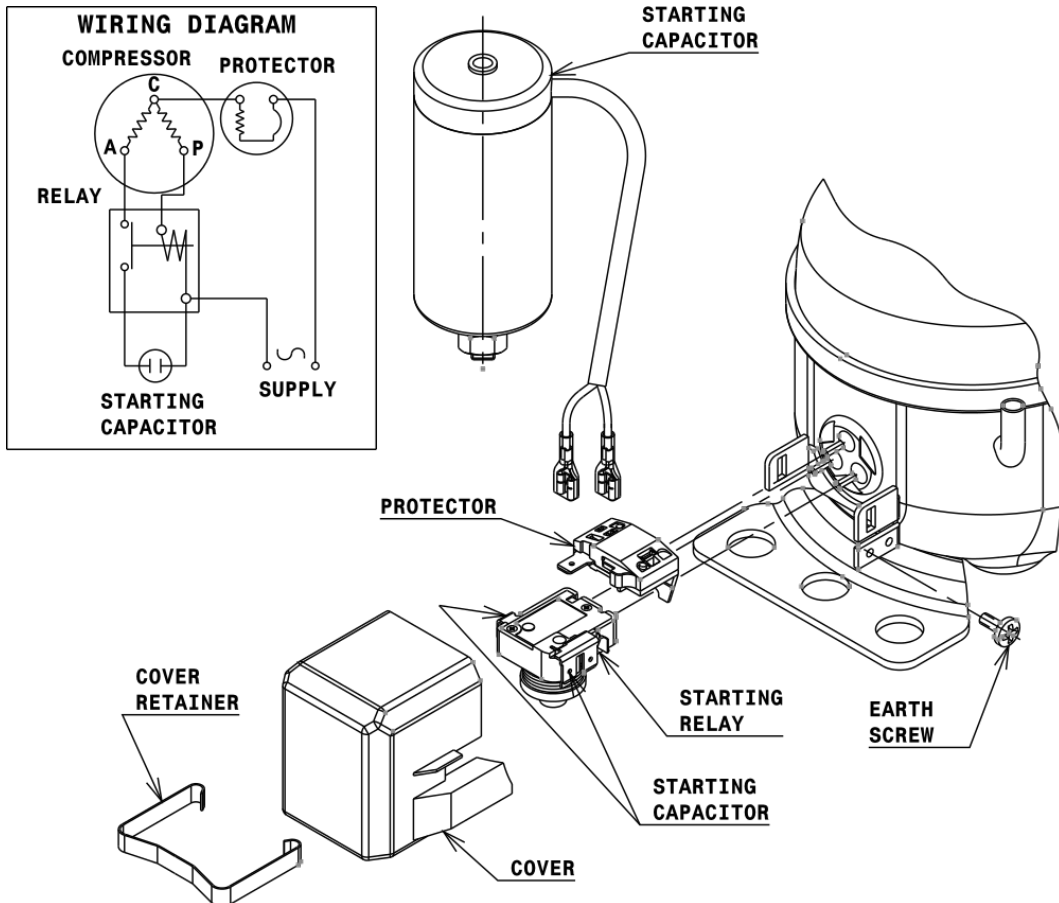

Technical Data Sheet

FIXINGS



SILENT BLOCKS (MOUNTING ACCESSORIES)

STANDARD

Ø16 holes (170x70 net)



SOA

SOA R134a HBP

