

Technical Data Sheet

Compressor model **B38G**
 Voltage **220-240V 50/60Hz ~1**
 Refrigerant **R134a**

APPLICATION

COMPRESSOR

MOTOR

Application	High Back Pressure	Displacement	3,80 cm ³	Nominal Power	1/8 hp
Refrigerant	R134a	Diameter	19,00 mm	Voltage/Frequency	220-240V 60Hz
Evaporating Temp.	-15,0 °C to 10,0 °C	Stroke	13,40 mm	Voltage range	187-255 V
Expansion	Capillar/Valve	Net Weight	5,40 Kg	Type	CSIR
Comp. Cooling	Static/Fan cooled	Oil type	POE 32	Phase number	1 PH
Max. ambient temp.	43,0 °C	Oil charge	120 cm ³	Locked Rotor Amps (LRA)	6,60 A
Compatible refriger.	R1234yf			Main W. resist. at 25°C	16,50 Ω
				Start W. resist. at 25°C	23,60 Ω

NOMINAL PERFORMANCE

APPROVALS

	ASHRAE	CECOMAF
Cooling Capacity	349 kCal/h	339 W
COP	2,31 W/W	1,98 W/W
EER	1,98 kCal/Wh	1,71 kCal/Wh
Input Power	176 W	171 W
Current	1,06 A	1,04 A



TEST CYCLE CONDITIONS

	ASHRAE HBP (D)	CECOMAF HBP (C)
Evaporating temp. (T _e)	7,2 °C	5,0 °C
Condensing temp. (T _c)	55,0 °C	55,0 °C
Liquid temp. (T _{liq.})	46,0 °C	55,0 °C
Ambient temp. (T _{amb.})	35,0 °C	32,0 °C
Suction temp. (T _{suction})	35,0 °C	32,0 °C
Voltage/Frequency	220 V 60 Hz	220 V 60 Hz

ELECTRICAL COMPONENTS

Starting capacitor	61 µF 330 V			
Relay	Option 1			
Reference	QL2-3.3			
Pick-Up	3,3 A			
Drop-Out	2,6 A			
Protector	Option 1			
Reference	DRB20S61A2			
Current				
Time check				
Disc temp. (Open/Close)	135,00 / 61,00 °C			

ASHRAE

Tc °C	Te °C	Cooling Capacity kCal/h	Consumption W	Current A	COP W/W	EER kCal/Wh
40	-15	164	103	0,83	1,86	1,60
40	-10	208	114	0,86	2,12	1,82
40	-5	262	125	0,89	2,43	2,09
40	0	324	136	0,92	2,77	2,38
40	5	396	147	0,96	3,14	2,70
40	7,2	431	151	0,97	3,32	2,85
40	10	477	157	0,99	3,55	3,05

45	-15	157	104	0,83	1,75	1,51
45	-10	196	117	0,87	1,95	1,68
45	-5	245	130	0,91	2,20	1,89
45	0	304	142	0,94	2,48	2,13
45	5	371	154	0,98	2,80	2,41
45	7,2	404	159	1,00	2,95	2,53
45	10	448	166	1,03	3,14	2,70

50	-15	149	106	0,83	1,64	1,41
50	-10	185	120	0,88	1,78	1,53
50	-5	229	135	0,92	1,98	1,70
50	0	283	148	0,96	2,22	1,90
50	5	346	162	1,01	2,48	2,14
50	7,2	376	168	1,03	2,61	2,24
50	10	418	175	1,06	2,78	2,39

55	-15	142	107	0,84	1,54	1,32
55	-10	173	123	0,88	1,63	1,40
55	-5	213	139	0,93	1,78	1,53
55	0	262	155	0,99	1,97	1,69
55	5	321	170	1,04	2,20	1,89
55	7,2	349	176	1,06	2,31	1,98
55	10	388	184	1,10	2,45	2,11

60	-15	134	109	0,84	1,44	1,24
60	-10	161	126	0,89	1,48	1,27
60	-5	196	144	0,95	1,59	1,37
60	0	241	161	1,01	1,75	1,50
60	5	295	177	1,07	1,94	1,67
60	7,2	322	184	1,10	2,03	1,75
60	10	359	193	1,13	2,16	1,86

65	-15	127	110	0,85	1,34	1,15
65	-10	149	130	0,90	1,34	1,15
65	-5	180	148	0,96	1,41	1,21
65	0	220	167	1,03	1,54	1,32
65	5	270	185	1,10	1,70	1,46
65	7,2	295	193	1,13	1,78	1,53
65	10	329	202	1,17	1,89	1,62

CECOMAF

Tc °C	Te °C	Cooling Capacity W	Consumption W	Current A	COP W/W	EER kCal/Wh
40	-15	177	103	0,83	1,71	1,48
40	-10	225	115	0,86	1,96	1,69
40	-5	282	126	0,89	2,24	1,93
40	0	350	137	0,93	2,55	2,20
40	5	427	148	0,96	2,89	2,50
40	7,2	464	152	0,98	3,05	2,64
40	10	513	158	1,00	3,26	2,82

45	-15	168	105	0,83	1,60	1,39
45	-10	211	118	0,87	1,79	1,54
45	-5	263	131	0,91	2,01	1,74
45	0	325	143	0,95	2,27	1,96
45	5	397	155	0,99	2,56	2,21
45	7,2	432	160	1,01	2,69	2,33
45	10	479	167	1,03	2,87	2,48

50	-15	159	106	0,84	1,50	1,29
50	-10	197	121	0,88	1,63	1,40
50	-5	244	135	0,92	1,80	1,56
50	0	301	149	0,97	2,02	1,74
50	5	368	163	1,02	2,26	1,95
50	7,2	400	169	1,04	2,37	2,05
50	10	444	176	1,06	2,52	2,18

55	-15	150	108	0,84	1,39	1,20
55	-10	183	124	0,89	1,47	1,27
55	-5	225	140	0,94	1,61	1,39
55	0	277	156	0,99	1,78	1,54
55	5	339	171	1,04	1,98	1,71
55	7,2	369	177	1,07	2,08	1,80
55	10	410	185	1,10	2,21	1,91

60	-15	141	109	0,84	1,29	1,12
60	-10	169	127	0,90	1,33	1,15
60	-5	206	145	0,95	1,42	1,23
60	0	253	162	1,01	1,56	1,35
60	5	309	178	1,07	1,73	1,50
60	7,2	337	186	1,10	1,82	1,57
60	10	376	195	1,14	1,93	1,67

65	-15	132	111	0,85	1,19	1,03
65	-10	155	130	0,91	1,19	1,03
65	-5	187	149	0,97	1,25	1,08
65	0	228	168	1,03	1,36	1,18
65	5	280	186	1,10	1,50	1,30
65	7,2	306	194	1,13	1,58	1,36
65	10	341	204	1,18	1,67	1,45

EN12900

X	Cooling Capacity (W)	Consumption (W)	Current (A)	Mass Flow (kg/h)
1	544,8303651895	89,8609700685	0,7505671087	9,2320822492926
2	22,6720846584	-0,3088366468	-0,0023882652	0,42920852905004
3	-4,9957559176	1,2675142180	0,0045988353	-0,038754390888275
4	0,1911150364	-0,0073242379	0,0000545445	0,0056209430957676
5	-0,2098899253	0,0634646418	0,0002484801	-0,0022325979488735

Equation	$x_1 + x_2Te + x_3Tc + x_4Te^2 + x_5TeTc$
----------	---

Technical Data Sheet

COMPRESSOR DIMENSIONS

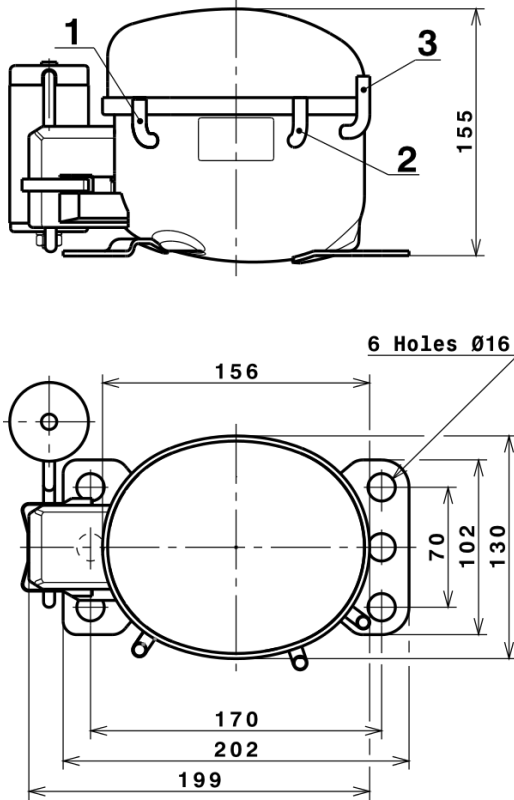

DESIGNATION INTERNAL DIAM.

DESIGNATION	INTERNAL DIAM.
1 Suction	6,1 mm
2 Service	6,1 mm
3 Discharge	5,1 mm

WIRING DIAGRAMS AND ELECTRICAL ASSEMBLY

CSIR CONNECTION (B, Small L ranges)

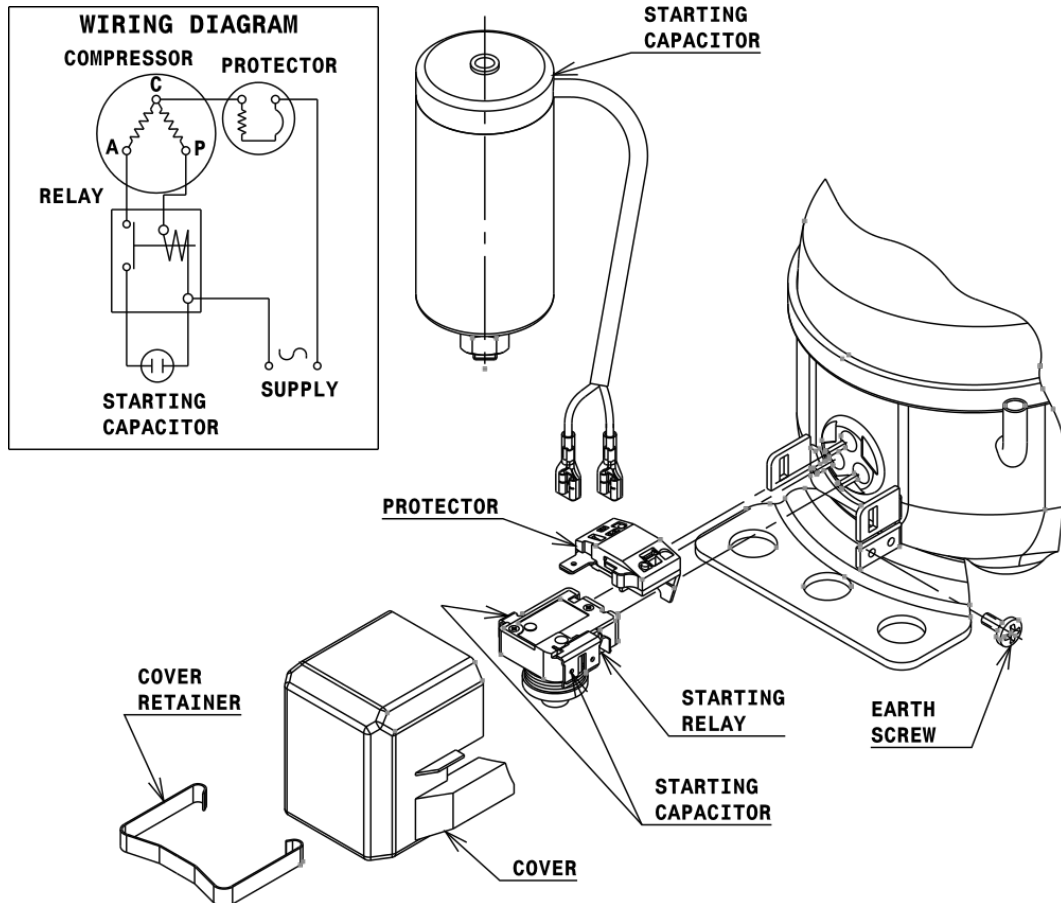

Technical Data Sheet

FIXINGS



SILENT BLOCKS (MOUNTING ACCESSORIES)

STANDARD

Ø16 holes (170x70 net)

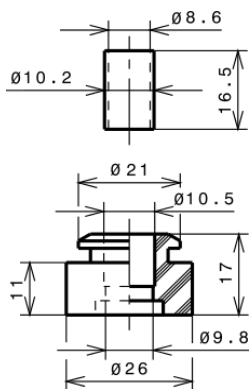

SOA

SOA R134a HBP

